

FontanaArte

MILANO 1932

THALEA

Paolo Rizzatto | Francesco Librizzi



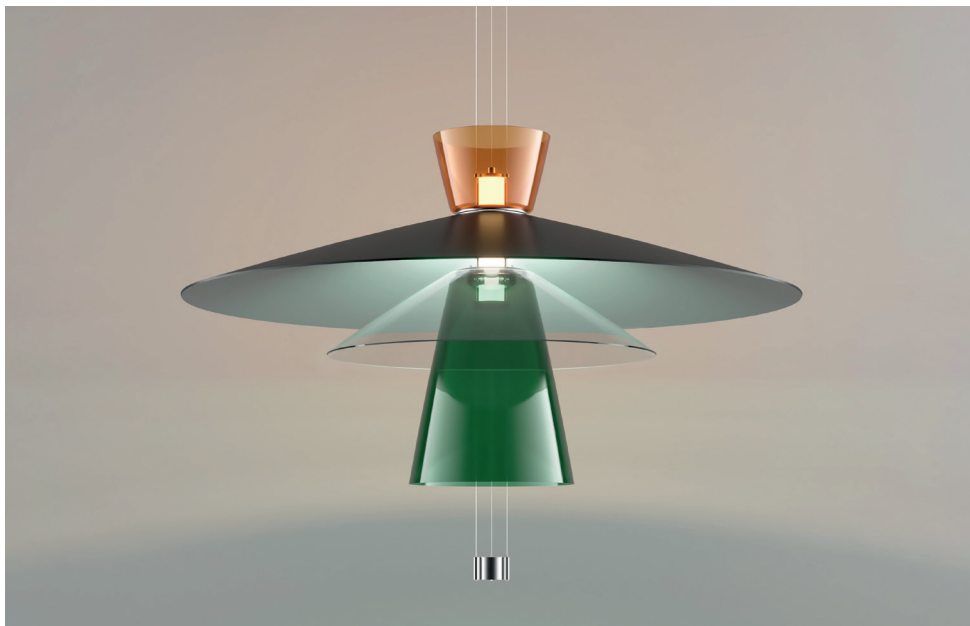

Dalla passione per la luce e il colore di Paolo Rizzatto e Francesco Librizzi nasce il progetto Thalea.

Una serie di paralumi in vetro borosilicato colorato e alluminio che, si possono comporre in configurazioni molteplici, ispirate alle proporzioni dei capolavori dell'arte rinascimentale italiana.

I paralumi, di diversa dimensione e ampiezza, sono di forma conica con una leggera bombatura che ne addolcisce la silhouette.

La gamma cromatica è ampia e spazia dai toni caldi ai freddi, combinati nelle diverse composizioni in armonia o a contrasto.

Due le sorgenti luminose, un LED dimmerabile che diffonde la luce nell'ambientale attraverso i vetri colorati e uno spot per illuminare direttamente le superfici.

Thalea richiama lo spirito senza tempo, in equilibrio tra arte e industria che ispira da sempre la produzione contemporanea di FontanaArte.

Una lampada componibile che dà spazio ai sogni e alle necessità di chi la sceglie.

The Thalea project comes from the passion for light and colour of Paolo Rizzatto and Francesco Librizzi.

A series of lampshades in coloured borosilicate glass and aluminum that, can be composed in multiple configurations, inspired by the proportions of masterpieces of Italian Renaissance art.

The lampshades vary in size and width and are conical in shape with a slight curvature that softens the silhouette.

The colour palette is wide and ranges from warm to cool tones, combined in different compositions in harmony or contrast.

Two light sources, dimmable LED that diffuses ambient light through the coloured glass and a spot light to illuminate the surfaces directly.

Thalea recalls the timeless spirit balanced between art and industry that has always inspired FontanaArte's contemporary production.

A modular lamp that shapes the dreams of those who choose and compose it.



COMPOSIZIONE / COMPOSITION

THR44841E210NB + THM44842E200AL + THV448410150VE + THV448430150BL + THV448420150TR + THS44841E200AL

THR44841E210NB

Rosone / Ceiling

● nero / black

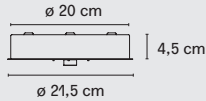

THM44841E200AL

con 1 ghiera di fissaggio /
with 1 fixing ring

max 2 accessori /
2 accessories max

LED 20W
(2700K, CRI >90, 2400Lm)
dimmerabile / dimmable DALI

● alluminio / aluminum

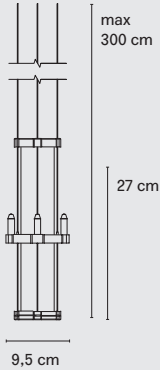

THM44842E200AL

con 2 ghiera di fissaggio /
with 2 fixing rings

max 4 accessori /
4 accessories max

LED 20W
(2700K, CRI >90, 2400Lm)
dimmerabile / dimmable DALI

● alluminio / aluminum

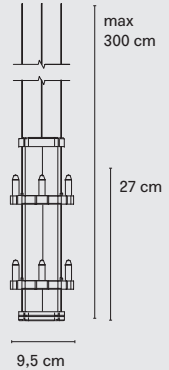

THV448410150..

Diffusore in vetro
Glass diffuser



THV448420150..

Diffusore in vetro
Glass diffuser

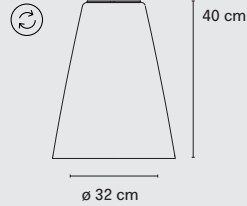

THV448430150..

Diffusore in vetro
Glass diffuser

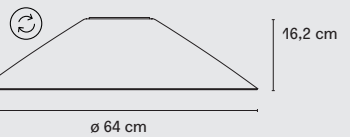

● AM (ambra / amber)

● RO (rosso / red)

● TR (trasparente / transparent)

● VE (verde / green)

● BL (blu / blue)

THP4484200NEBI

Paralume in metallo
Metal diffuser

● nero, bianco / black, white

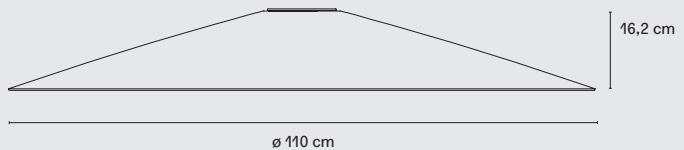

THS44841E200AL

Spot
Spot

LED 8W
(2700K, CRI 90, 1000Lm)
dimmerabile / dimmable DALI

● alluminio / aluminum

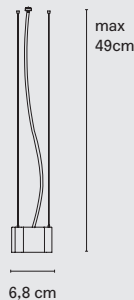

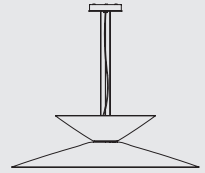
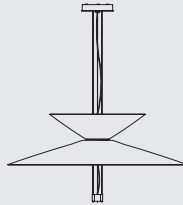
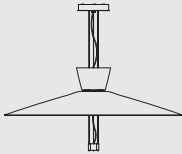
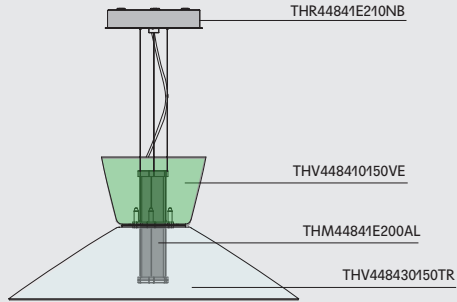

THR44841E210NB

rosone / ceiling

+

THV448410150..

diffusore in vetro / glass diffuser
d.23 cm



+

THP4484200BINE

diffusore in metallo / metal diffuser

+

THM44841E200AL

corpo luce lineare / linear light body

+

THS44841E200AL

spot

THR44841E210NB

rosone / ceiling

+

THV448410150..

diffusore in vetro / glass diffuser
d.23



+

THV448430150..

diffusore in vetro / glass diffuser
d.64 cm



+

THM44841E200AL

corpo luce lineare / linear light body

THR44841E210NB

rosone / ceiling

+

THV448430150..

diffusore in vetro / glass diffuser
d.64



+

THP4484200BINE

diffusore in metallo / metal diffuser

+

THM44841E200AL

corpo luce lineare / linear light body

+

THS44841E200AL

spot

THR44841E210NB

rosone / ceiling

+

THV448430150..

diffusore in vetro / glass diffuser
d.64



+

THP4484200NEBI

diffusore in metallo / metal diffuser

+

THM44841E200AL

corpo luce lineare / linear light body



THR44841E210NB

rosone / ceiling

+

THV448410150..

diffusore in vetro / glass diffuser
d.23

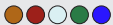

+

THV448420150..

diffusore in vetro / glass di user
d.32 cm



+

THM44841E200AL

corpo luce lineare / linear light body

+

THS44841E200AL

spot

THR44841E210NB

rosone / ceiling

+

THV448410150..

diffusore in vetro / glass diffuser
d.23 cm



+

THV448420150..

diffusore in vetro / glass di user
d.32 cm



+

THM44841E200AL

corpo luce lineare / linear light body

THR44841E210NB

rosone / ceiling

+

2 x THV448410150..

diffusore in vetro / glass diffuser
d.23



+

THM44841E200AL

corpo luce lineare / linear light body

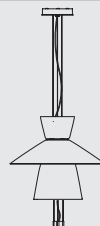
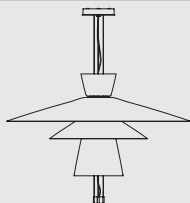
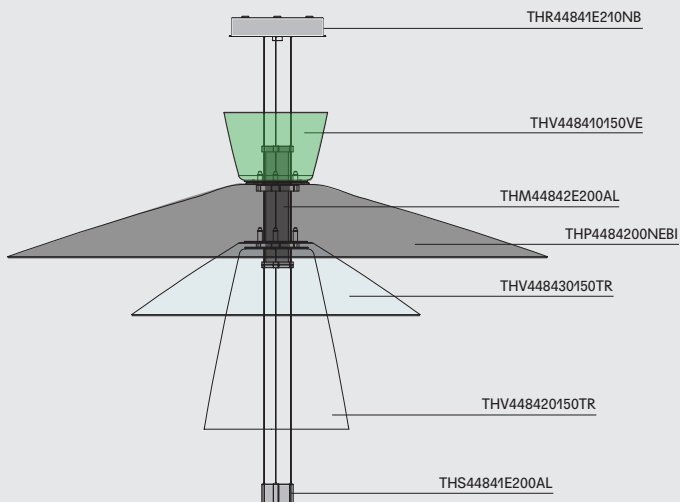

THR44841E210NB
rosone / *ceiling*
+
THV448410150..
diffusore in vetro / *glass diffuser* d.23 cm
● ● ● ● ●
+
THP4484200BINE
diffusore in metallo / *metal diffuser*
+
THV448430150..
diffusore in vetro / *glass diffuser* d.64 cm
● ● ● ● ●
+
THV448420150..
diffusore in vetro / *glass di user* d.32 cm
● ● ● ● ●
+
THM44842E200AL
corpo luce lineare / *linear light body*
+
THS44841E200AL
spot

THR44841E210NB
rosone / *ceiling*
+
THV448410150..
diffusore in vetro / *glass diffuser* d.23
● ● ● ● ●
+
THV448420150..
diffusore in vetro / *glass di user* d.32 cm
● ● ● ● ●
+
THV448430150..
diffusore in vetro / *glass di user* d.64
● ● ● ● ●
+
THM44842E200AL
corpo luce lineare / *linear light body*
+
THS44841E200AL
spot



COMPOSIZIONE / COMPOSITION

THR44841E210NB + THM44841E200AL + THV448430150RO + THP4484200NEBI



fontanaarte.com